

## N-Channel MOSFET

### 2KK5021

#### ■ Features

- $V_{DS} = 130V$
- $I_D = 2.3 A$  ( $V_{GS} = 10V$ )
- $R_{DS(ON)} < 240m\Omega$  ( $V_{GS} = 10V$ )
- $R_{DS(ON)} < 260m\Omega$  ( $V_{GS} = 6V$ )
- Fast switching speed

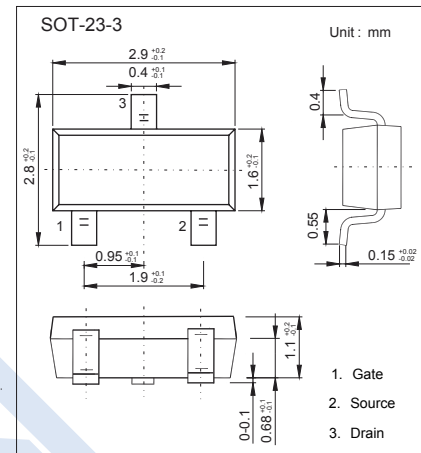
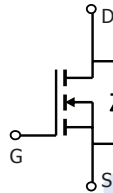

#### ■ Absolute Maximum Ratings $T_a = 25^\circ C$

Parameter	Symbol	Rating	Unit
Drain-Source Voltage	$V_{DS}$	130	V
Gate-Source Voltage	$V_{GS}$	$\pm 20$	
Continuous Drain Current	$I_D$	2.3	A
Pulsed Drain Current	$I_{DM}$	10	
Power Dissipation	(Note.1)	1.6	W
	(Note.2)	0.8	
Single Pulse Avalanche Energy	(Note.3)	12	mJ
Thermal Resistance.Junction- to-Ambient	(Note.1)	78	$^\circ C/W$
Thermal Resistance.Junction- to-Case	$R_{thJC}$	30	
Junction Temperature	$T_J$	150	$^\circ C$
Storage Temperature Range	$T_{stg}$	-55 to 150	

Note.1: 78  $^\circ C/W$  when mounted on a 1 in<sup>2</sup> pad of 2 oz copper

Note.2: 175  $^\circ C/W$  when mounted on a minimum pad of 2 oz copper

Note.3: Starting  $T_J = 25^\circ C$ ,  $L = 1.0 mH$ ,  $I_{AS} = 5.0 A$ ,  $V_{DD} = 115 V$ ,  $V_{GS} = 10 V$ .

## N-Channel MOSFET

### 2KK5021

#### ■ Electrical Characteristics Ta = 25°C

Parameter	Symbol	Test Conditions	Min	Typ	Max	Unit
Drain-Source Breakdown Voltage	V <sub>DSS</sub>	I <sub>D</sub> =250 μA, V <sub>GS</sub> =0V	130			V
Zero Gate Voltage Drain Current	I <sub>DSS</sub>	V <sub>DS</sub> =120V, V <sub>GS</sub> =0V			1	μA
Gate-Body Leakage Current	I <sub>GSS</sub>	V <sub>DS</sub> =0V, V <sub>GS</sub> =±20V			±100	nA
Gate Threshold Voltage	V <sub>GS(th)</sub>	V <sub>DS</sub> =V <sub>GS</sub> , I <sub>D</sub> =250 μA	2		4	V
Static Drain-Source On-Resistance	R <sub>DS(on)</sub>	V <sub>GS</sub> =10V, I <sub>D</sub> =2.3A			240	mΩ
		V <sub>GS</sub> =10V, I <sub>D</sub> =2.3A T <sub>J</sub> =125°C			453	
		V <sub>GS</sub> =6V, I <sub>D</sub> =1.9A			260	
Forward Transconductance	g <sub>FS</sub>	V <sub>DS</sub> =5V, I <sub>D</sub> =2.3A		6		S
Input Capacitance	C <sub>iss</sub>	V <sub>GS</sub> =0V, V <sub>DS</sub> =75V, f=1MHz		260	345	pF
Output Capacitance	C <sub>oss</sub>			32	45	
Reverse Transfer Capacitance	C <sub>rss</sub>			1.7	5	
Gate Resistance	R <sub>g</sub>	V <sub>GS</sub> =0V, V <sub>DS</sub> =0V, f=1MHz		1.3		Ω
Total Gate Charge	Q <sub>g</sub>	V <sub>GS</sub> =0 to 10V, V <sub>DS</sub> =75V, I <sub>D</sub> =2.3A		4.2	6	
				2.4	4	nC
Gate Source Charge	Q <sub>gs</sub>	V <sub>GS</sub> =0 to 5V, V <sub>DS</sub> =75V, I <sub>D</sub> =2.3A		1		
Gate Drain Charge	Q <sub>gd</sub>			1		
Turn-On DelayTime	t <sub>d(on)</sub>	V <sub>DD</sub> = 75 V, I <sub>D</sub> = 2.3 A, V <sub>GS</sub> = 10 V, R <sub>GEN</sub> = 6 Ω		4.7	10	ns
Turn-On Rise Time	t <sub>r</sub>			1.4	10	
Turn-Off DelayTime	t <sub>d(off)</sub>			10	20	
Turn-Off Fall Time	t <sub>f</sub>			3.1	10	
Body Diode Reverse Recovery Time	t <sub>rr</sub>			45	73	
Body Diode Reverse Recovery Charge	Q <sub>rr</sub>	I <sub>F</sub> = 2.3A, di/dt= 100A/μs		33	53	nC
Maximum Body-Diode Continuous Current	I <sub>S</sub>				2.3	A
Diode Forward Voltage	V <sub>SD</sub>	I <sub>S</sub> =2.3A, V <sub>GS</sub> =0V			1.3	V

Note : Pulse Test: Pulse Width < 300 μs, Duty cycle < 2.0 %.

#### ■ Marking

Marking	KAK
---------	-----

## N-Channel MOSFET 2KK5021

■ Typical Characteristics

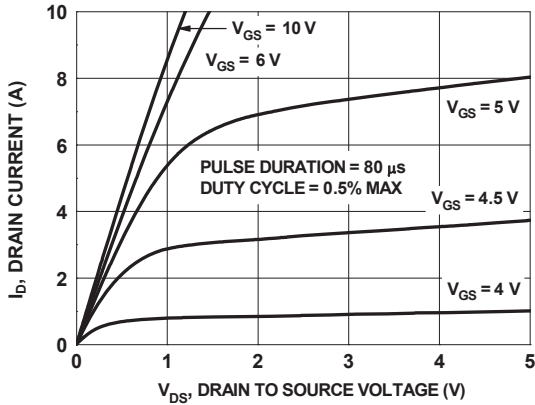

Figure 1. On-Region Characteristics

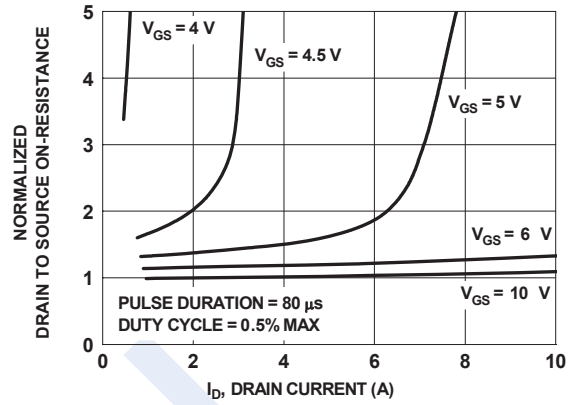
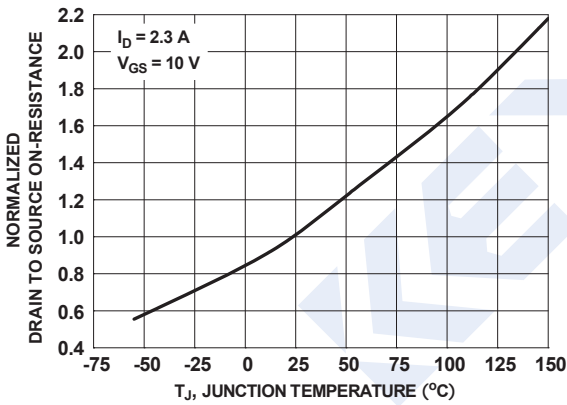

Figure 2. Normalized On-Resistance vs Drain Current and Gate Voltage



vs Junction Temperature

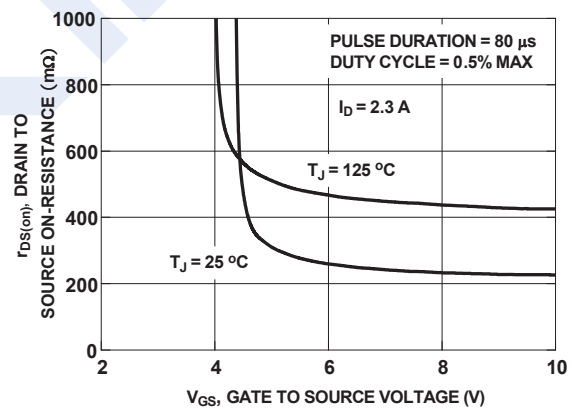

Figure 4. On-Resistance vs Gate to Source Voltage

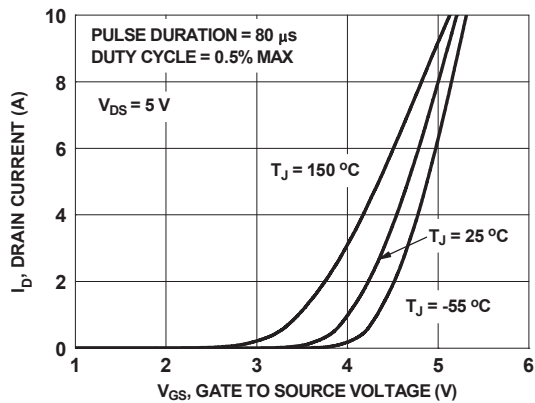

Figure 5. Transfer Characteristics

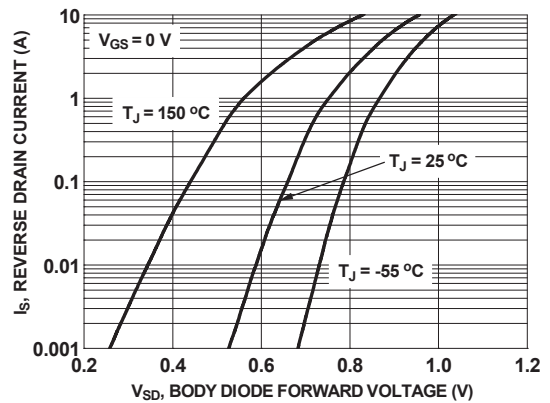

Figure 6. Source to Drain Diode Forward Voltage vs Source Current

## N-Channel MOSFET 2KK5021

■ Typical Characteristics

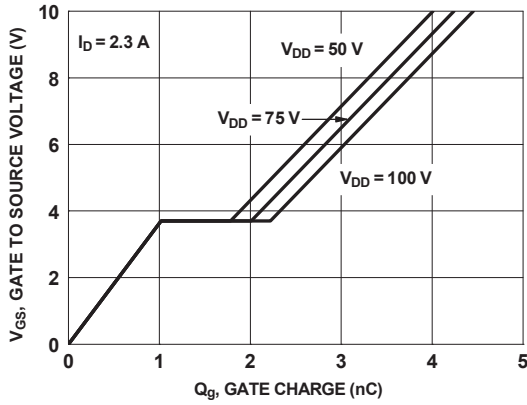

Figure 7. Gate Charge Characteristics

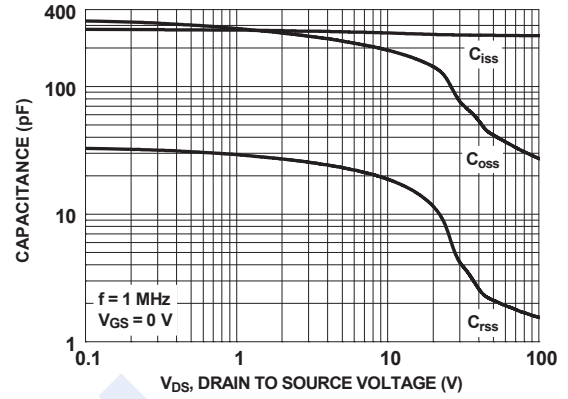

Figure 8. Capacitance vs Drain to Source Voltage

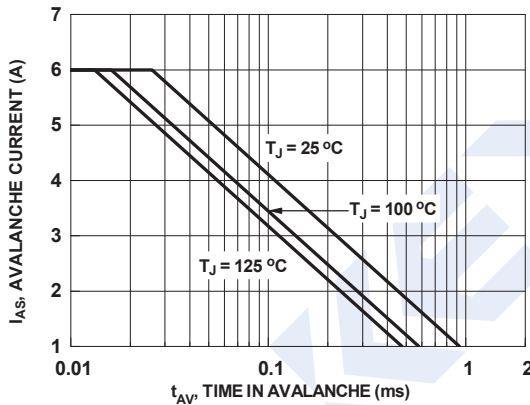

Figure 9. Unclamped Inductive Switching Capability

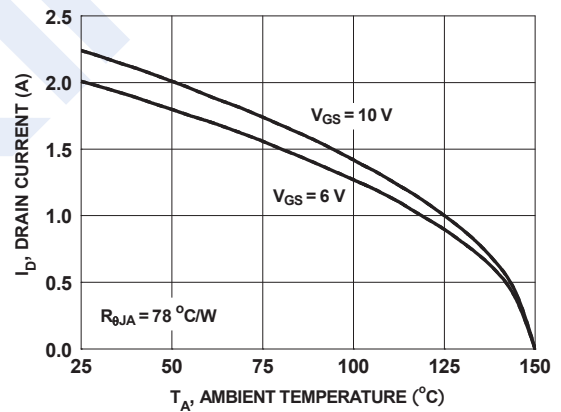

Figure 10. Maximum Continuous Drain Current vs Ambient Temperature

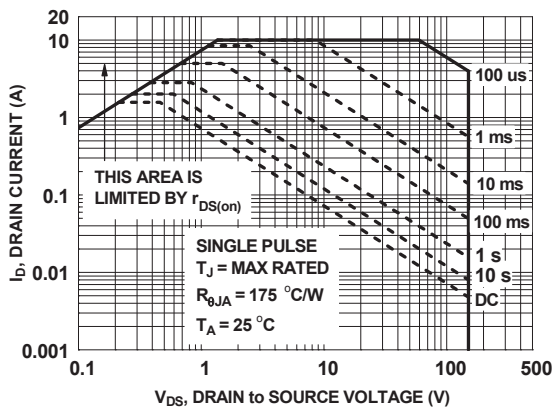

Figure 11. Forward Bias Safe Operating Area

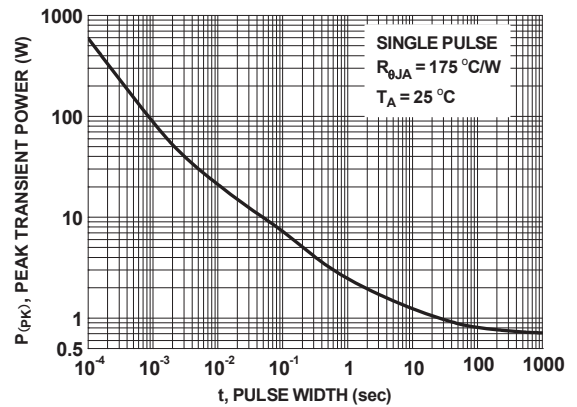

Figure 12. Single Pulse Maximum Power Dissipation

## N-Channel MOSFET 2KK5021

### Typical Characteristics

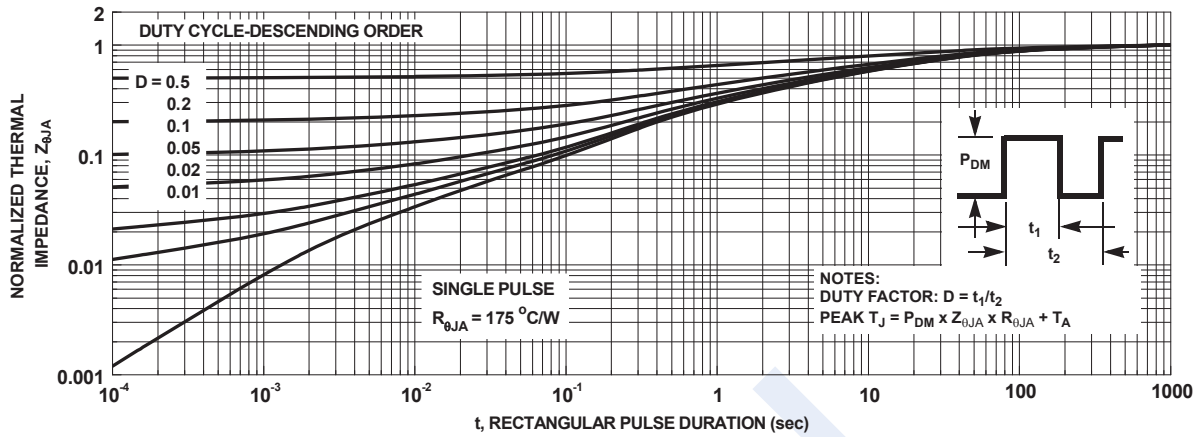

Figure 13. Junction-to-Ambient Transient Thermal Response Curve